

Greek Solar Thermal Market TRANSOLAR – ZAGREB

23 & 24 APRIL 2009

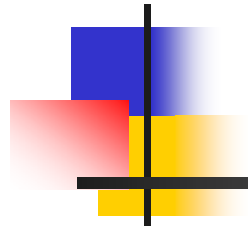

Market Development and Tools
Awareness, International Trade

ECONOMOU APOSTOLOS

MECHANICAL ENGINEER

Executive Secretary GSIA



Greek Solar Thermal Market

One the most successful
countries worldwide in
Solar System applications



Greek Solar Industry Association



ΕΝΩΣΗ ΒΙΟΜΗΧΑΝΙΩΝ ΗΛΙΑΚΗΣ ΕΝΕΡΓΕΙΑΣ

Acharnon 315, GR-111 45 Athens

Tel. +30210 2112591 / Fax. 2112592

www.ebhe.gr

Email : info@ebhe.gr

GSIA Members

Est.1979

Si ma
Solar Systems

Alpak

DIANA
ΕΠΙ ΑΦ' ΕΛΕΓΧΕΤΟΣ ΠΑΡΑΓΩΓΗΣ

MALTEZOS

SIELINE

PAPAEMMANOUEL-S.A.

Solar Flame
Solar Systems

SAMMLER

ΣΗΕ

ΗΛΙΟΘΕΡΜΟ

ΗΛΙΟΘΕΡΜΑ-ΠΟΛΥΚΟΥΖΙΝΑ
Kipriotakis
2810-381300

HELIOAKMI

EBHA
EBIL

THERMOHELLAS

MELPO

Intersolar

SONNE
Aktion

HELIONAL
Solar Systems

HOWAT

ΗΛΙΑΚΑ ΣΥΣΤΗΜΑΤΑ
ΔΗΜΑΣ

NOBEL
XYLINAKIS

ROMINA

STIBETHERM



Products in Greece

- Solar water heater Thermosiphonic 95%
 - Private customers
- Central pump systems
 - Mainly professional customers
 - Hot water for hotels (95%), hospitals, etc
 - Process hot water
 - Solar cooling

Domestic Pump System

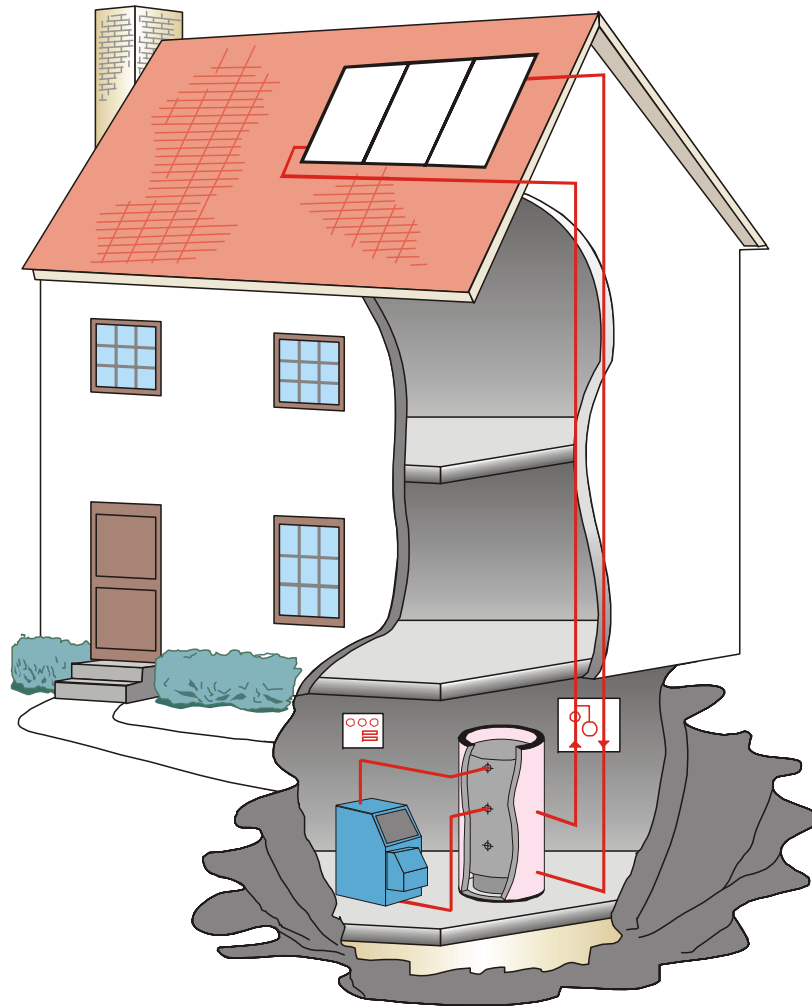

Thermosiphonic Water Heater

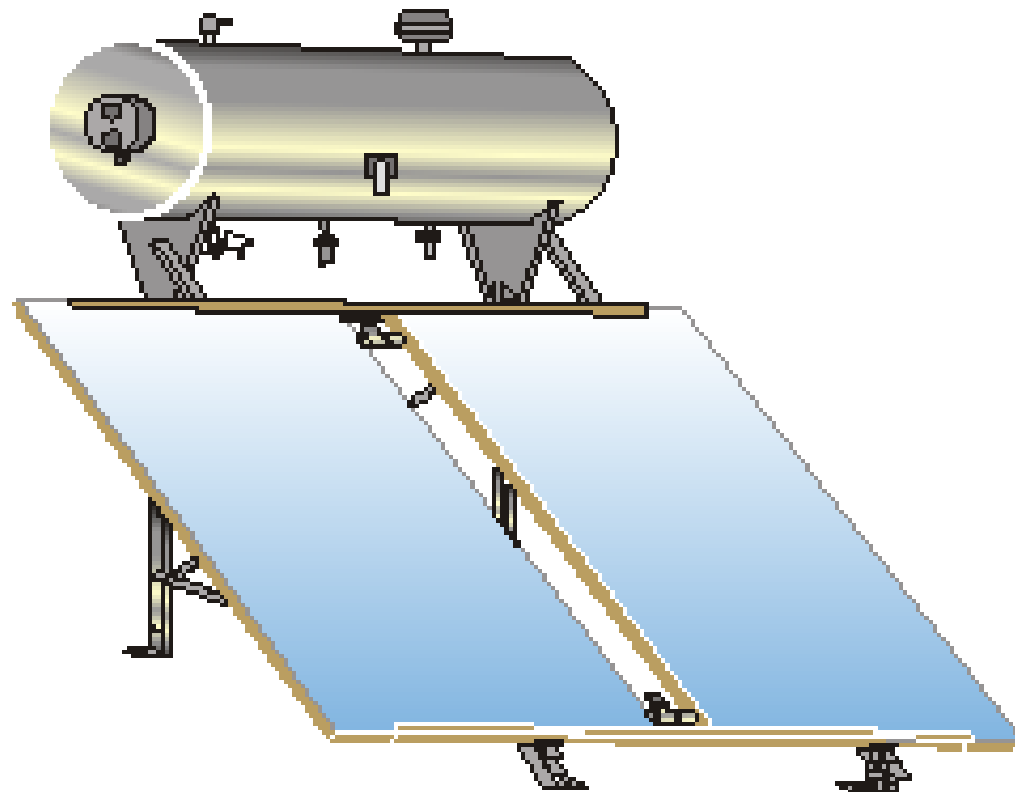



Thermosiphonic Water Heater

- Requires flat roof or integration on roof or acceptance by customer
- Inexpensive installation
- Simple installation
 - No mistakes by installers
 - No negative influence on customers by installers



Sales

■ Sales of solar collectors (m²) in the Greek Market ■ Export

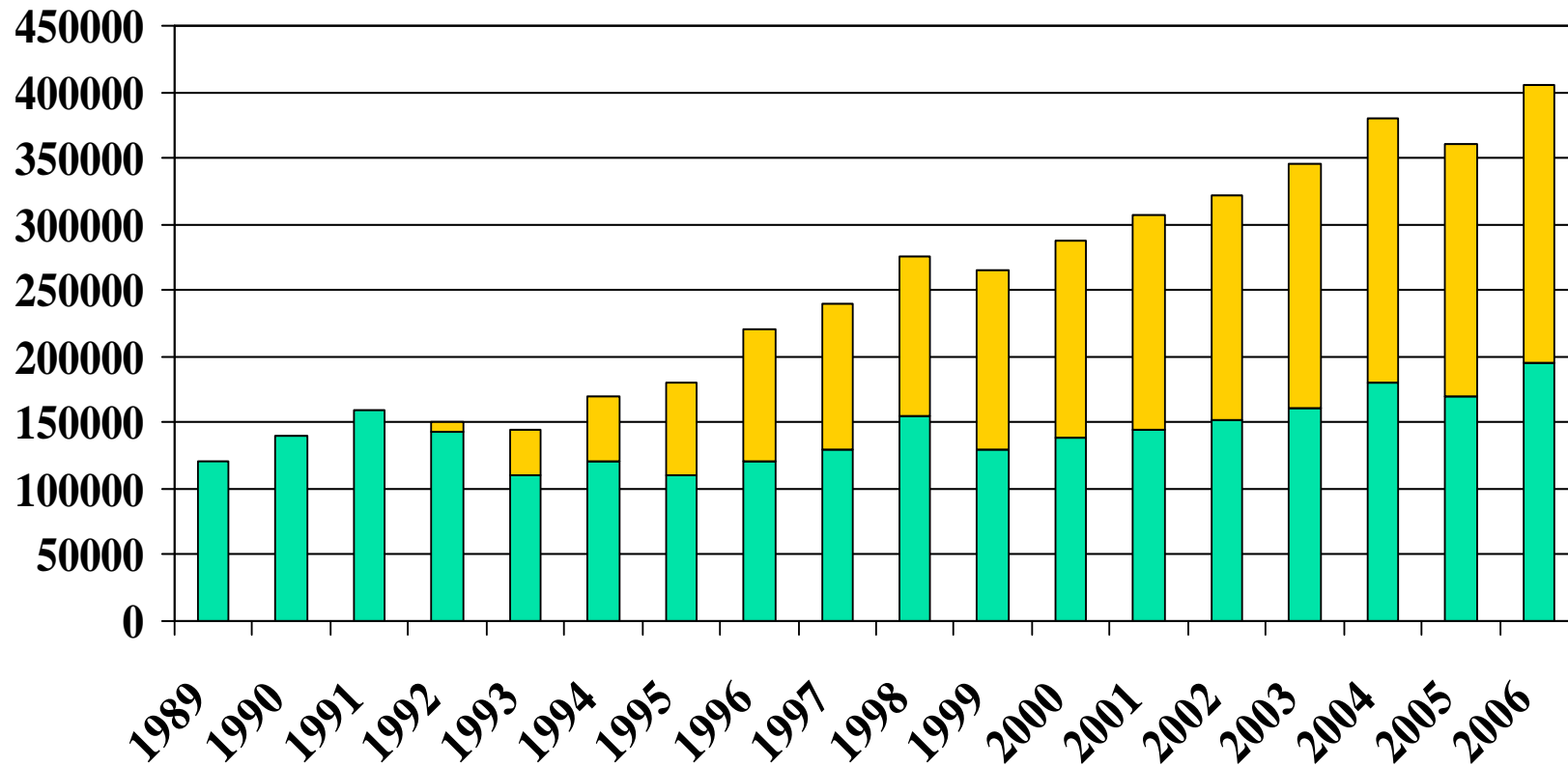

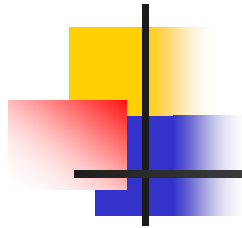

GREEK SOLAR MARKET SALES

Greek Solar Market

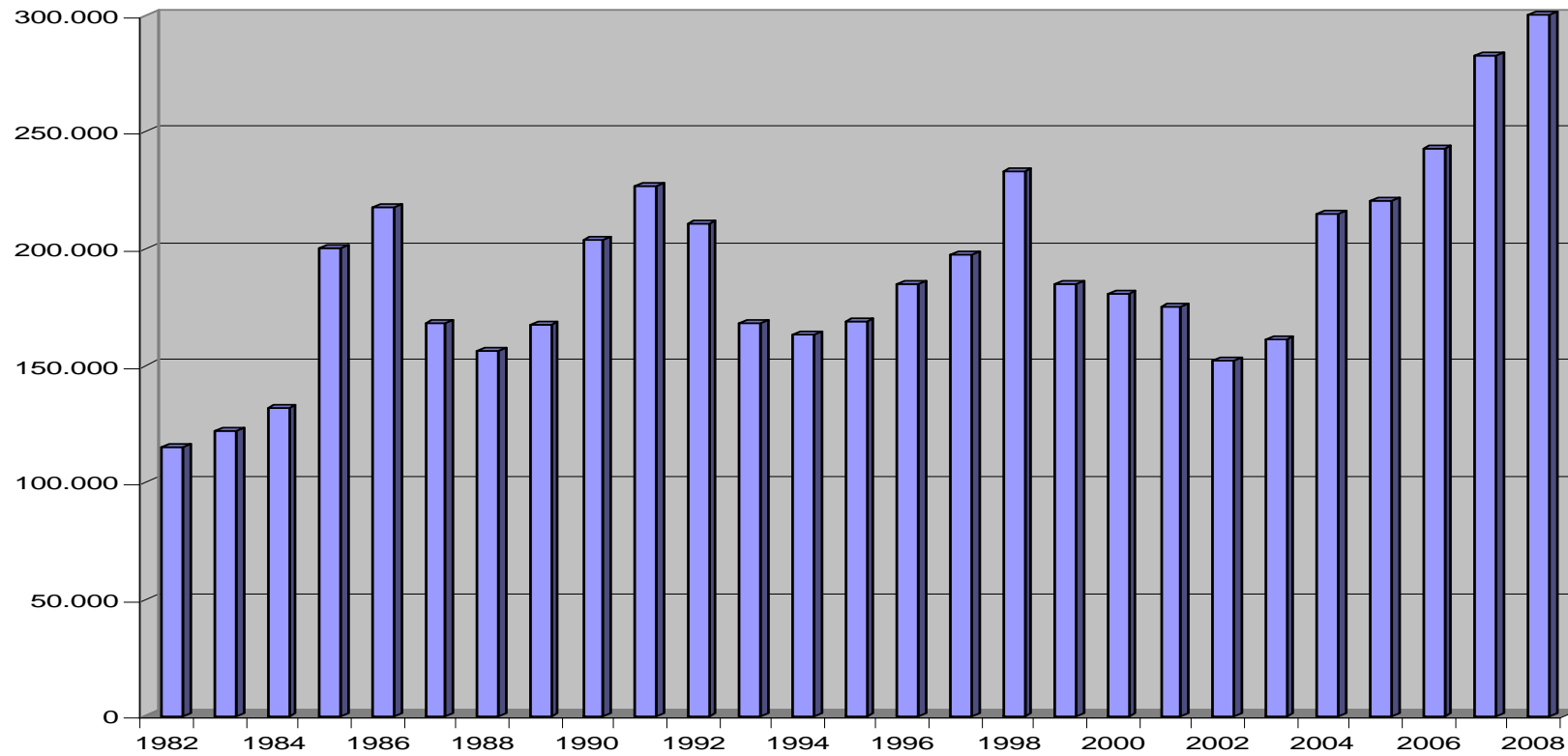

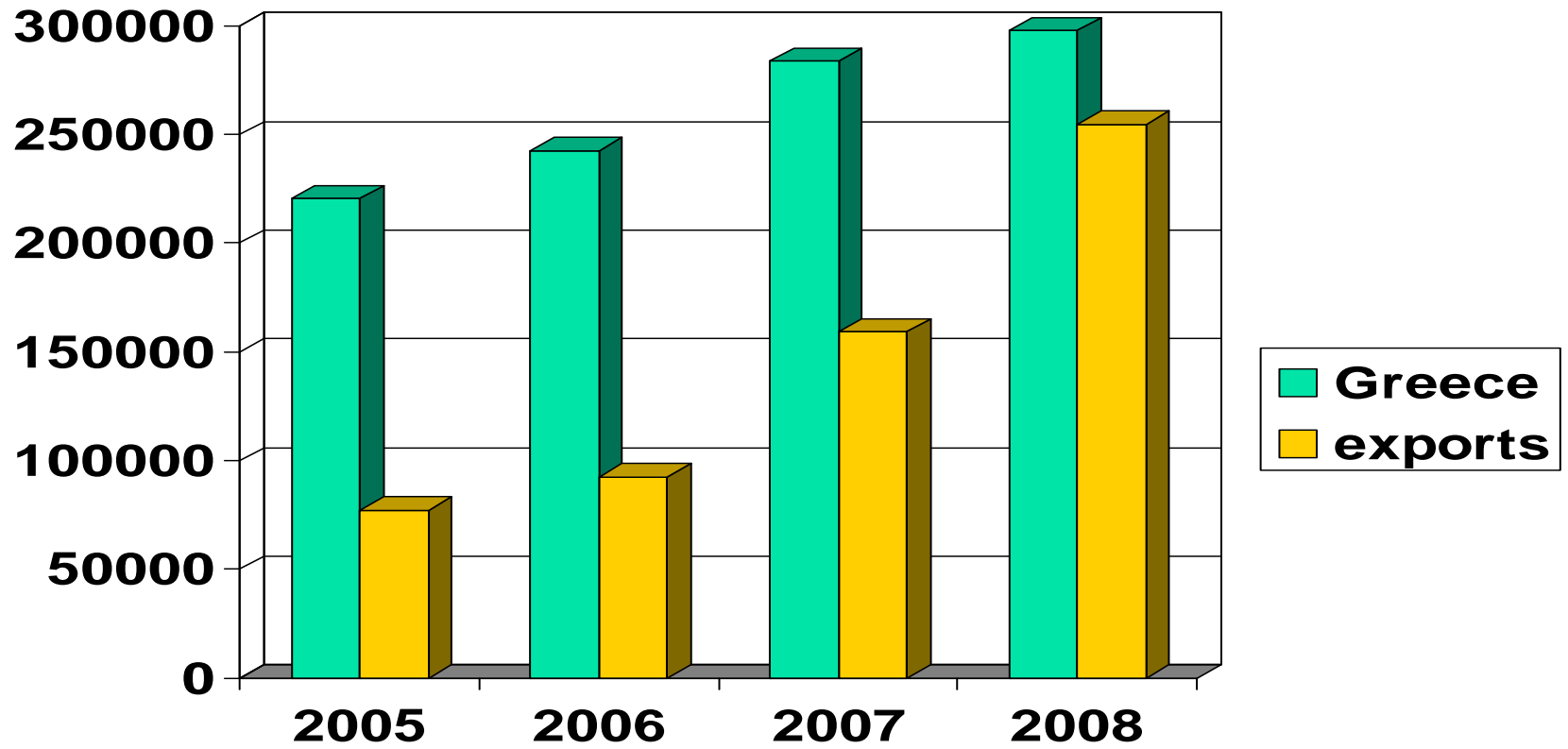
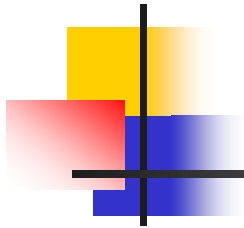

EUROPEAN SOLAR THERMAL MARKET

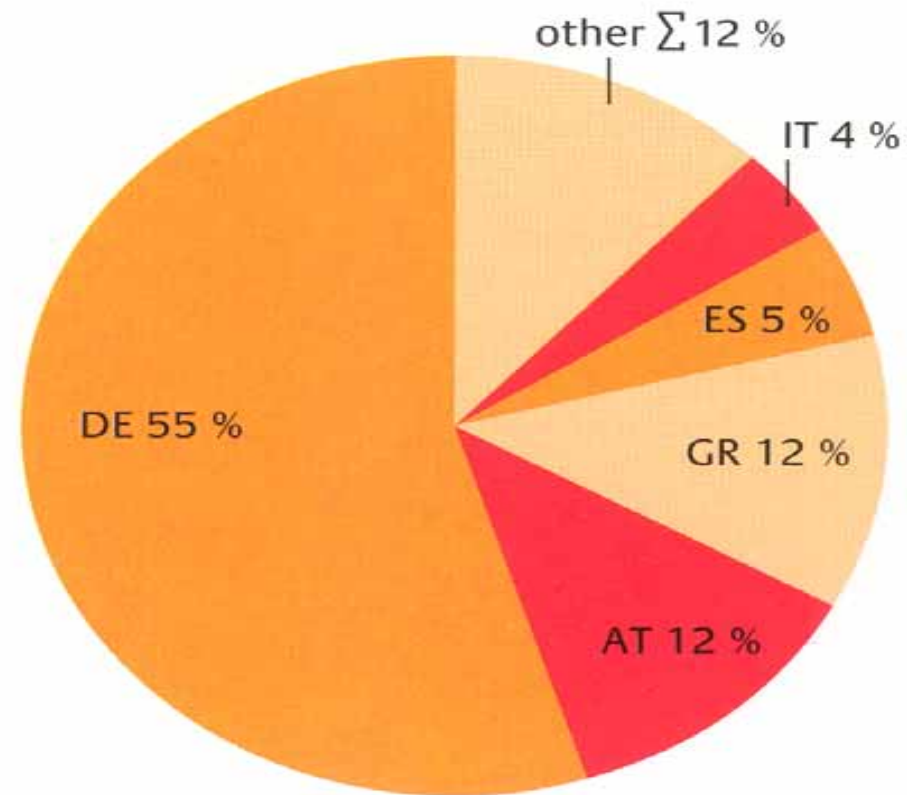

WORLD SOLAR THERMAL MARKET IN M2

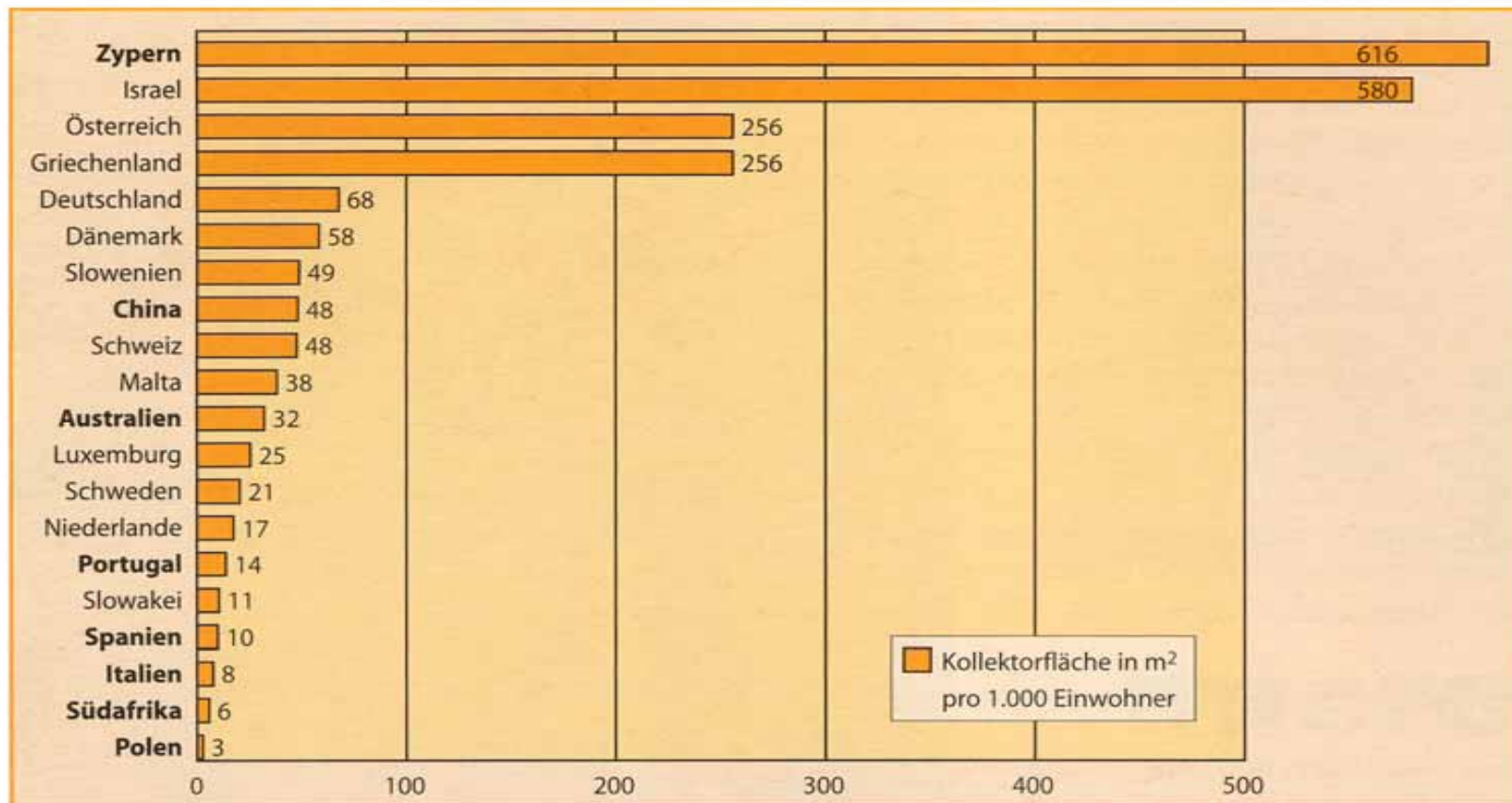



GREEK FIGURES - 2008

Installed collector area

- 3.550.000 m² or 2.485.000 kW

Yearly savings

- 1.952.500 MWh
- 2.000.000 tn CO₂

- 3.300 jobs
- 250.000.000 Euro



COMPARISON BETWEEN GREEK SOLAR MARKET & THE REST OF EUROPE -2006

	<u>GREECE</u>	<u>EUROPE</u>
■ SOLAR COLLECTOR IN USE (m ²)	3 mil.	16 mil.
■ OIL CONSERVATION (TONS/YEARS)	265 thous	1400 thous
■ DIMINATION OF POLLUTION (TONS/YEARS)	800 thous	4000 thous
■ INSTALLED POWER (MW)	2000	11700



Market Structure Now

Manufacturer

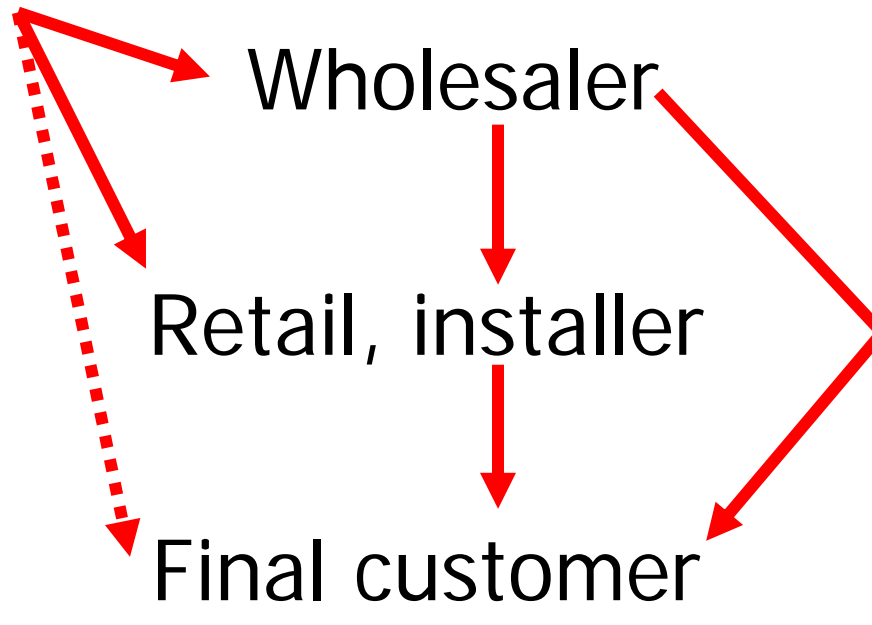

HVAC



Initial Market Structure

Manufacturer

Manufacturer

Wholesaler (solar only)

Final customer

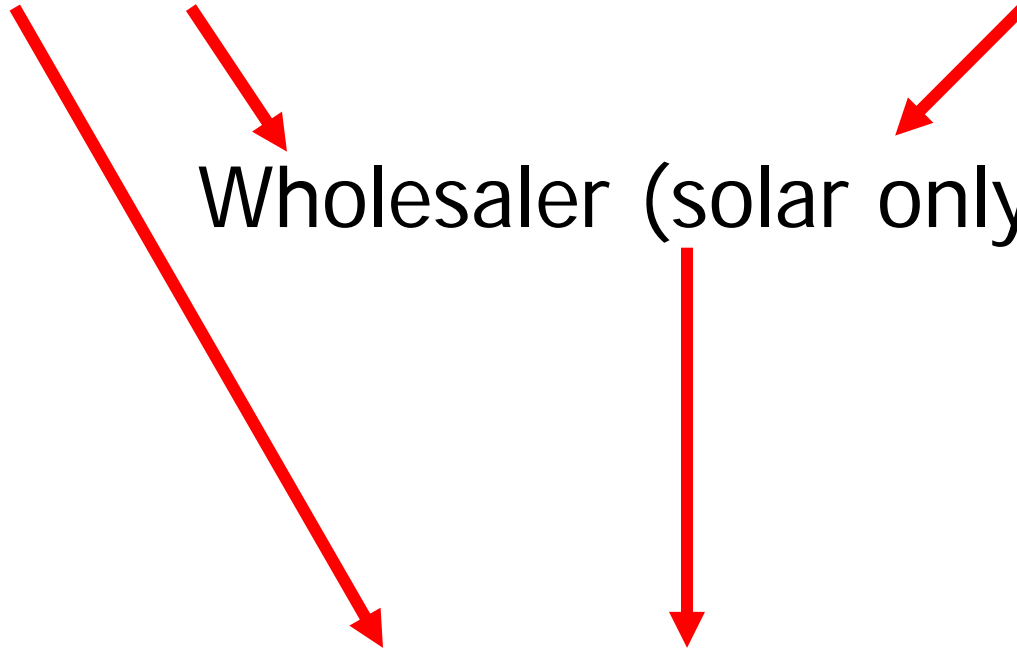



Advertising/Awareness Campaigns

- 1979-1981 Industry, State
(benefits of solar energy)
- 1984-1985 Industry, State
(economy)
- 1995 Public Power Corporation



Awareness for Solar

- **Hot water** : Complete
- **Process heat** : not satisfactory
- **Space heating** : only 'futuristic'
- **Solar cooling** : 'startup phase'
- Other in project level (drying, etc.)



International Trade

Positive

- European safety requirements CE mark
- European standards

- Solar Keymark



Negative

- National & regional requirements



Exported Products

- **Solar water heaters** (Mediterranean, 37 countries all over)
- **Solar collectors** (Europe, mainly central)
- **Small solar tanks** - suitable for thermosiphonic systems- (Mediterranean)
- **Absorbers, etc.-** (Eastern Europe)



Key to Enlarge Solar Market

Simple and long term rules for subsidies



MEMBERS OF EBHE

- PLEASE VISIT OUR WEB SITE :

WWW.EBHE.GR